



15/40/80CN Series

Coreless Medium Pressure Filters



ENGINEERING YOUR SUCCESS.

15/40/80CN Series

Applications

- Compressor Lube Oil
- Off-line Filter Loops
- Machine Tools
(Automotive Standard)
- Hydrostatic Drive
Charge Pumps
- Mobile Equipment
- Pilot Lines For Servo Controls
- Oil Patch Drilling Equipment
- Injection Molding



This partial list of applications for Parker CN series filters has a common factor, the need for an economical, medium pressure range filter with excellent fatigue pressure ratings. Prior to the availability of the CN filter, applications such as those listed were restricted by limitations of a spin-on can, or forced into the higher cost range of high pressure filters.

The CN series fills this gap, and now with the newly increased fatigue rating from 550 to 800 psi, the applications are expanded.

Feature	Advantage	Benefit
800 psi fatigue rating (eight times that of a spin-on)	<ul style="list-style-type: none"> • Ability to provide reliable service under tough cyclic operating conditions • Can be utilized in applications where high pressure filters may have been the only option 	<ul style="list-style-type: none"> • Reduced downtime due to premature filter failures • Reduce costs, better “fit” for the application
Diametral (side) seal between head and bowl	<ul style="list-style-type: none"> • Proven reliability in cyclic applications • Reduced importance of bowl torque 	<ul style="list-style-type: none"> • No downtime, no leaks • Performs with “real world” service
Dust seal	<ul style="list-style-type: none"> • Prevents contamination from building up on bowl / head threads 	<ul style="list-style-type: none"> • Easier service, no galling
Cast aluminum head	<ul style="list-style-type: none"> • Low profile, lightweight and durable 	<ul style="list-style-type: none"> • Less weight, smaller envelope and cleaner appearance
Standard Microglass elements	<ul style="list-style-type: none"> • Multi-layered design produced high capacity and efficiency • Reduces pleat bunching, keeps performance consistent 	<ul style="list-style-type: none"> • Great performance value • Reliable performance throughout element life • Reduces downtime, maximizes element life
Complete performance data disclosure	<ul style="list-style-type: none"> • All pertinent information is provided in an easy-to-compare format 	<ul style="list-style-type: none"> • No hidden deficiencies • Easy selection of proper filtration
Visual, electrical or electrical/visual indicators available	<ul style="list-style-type: none"> • Check element condition at a glance • Right style for the application 	<ul style="list-style-type: none"> • Optimize element life, prevent bypassing • Matches your system electrical connections

15/40/80CN Series

Features

Ports

SAE, NPT or flange face (80CN) provides mounting flexibility.

Element Condition Indicators

Available in visual or electrical, with a choice of several power connections (E3 shown).

Head

Cast aluminum is rugged with small profile for easy mounting.

Diametral (side) Seal

Dust Seal

Protects head and bowl threads from external contamination buildup.

Bypass

Cartridge style bypass has good sealing characteristics and low hysteresis. Choice of two settings to match application needs.

Element Assembly

Bowl

Aluminum is lightweight and corrosion resistant.

Drain Port (optional)

Optional drain port allows for easy element servicing.

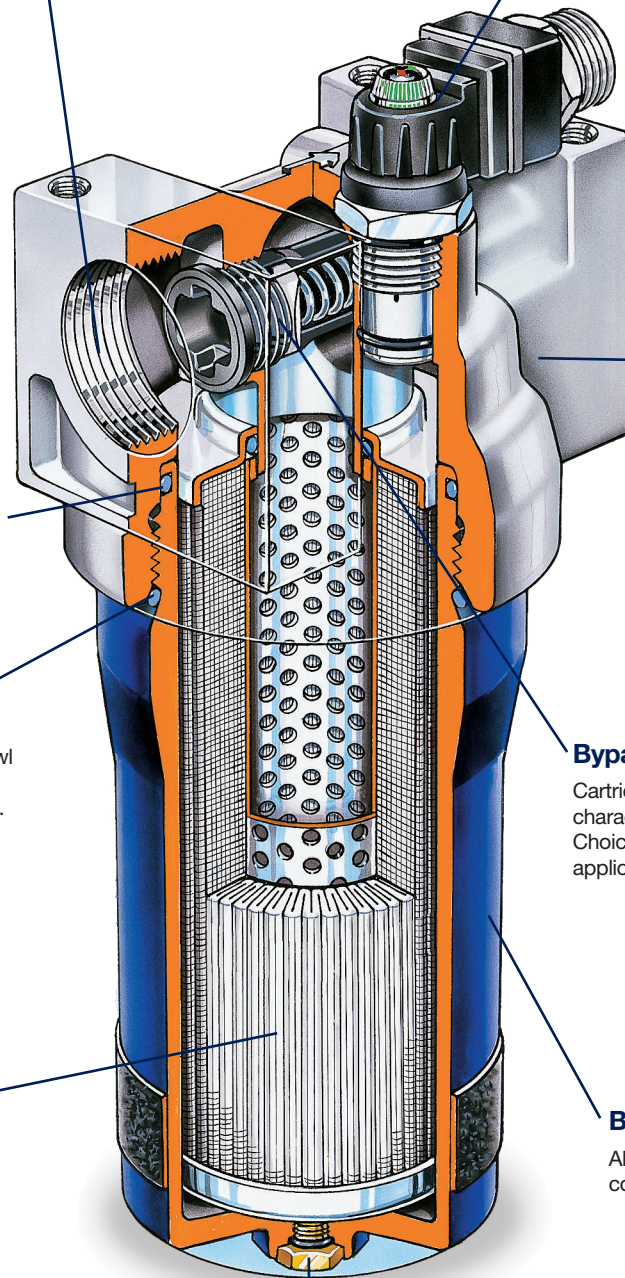

15CN Series

15CN-1 Element Performance

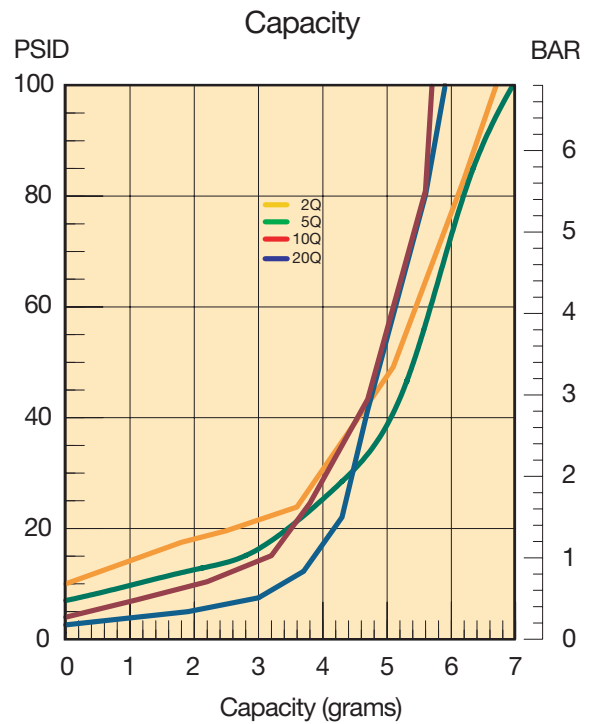
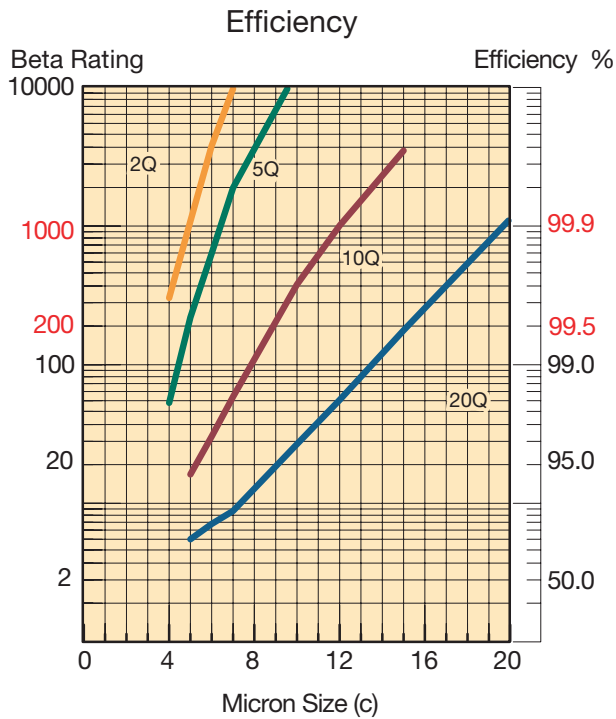

Results typical from Multi-pass tests run per test standard ISO 16889 @ 10 gpm to 100 psid terminal - 10 mg/L BUGL
Refer to Appendix for relationship to test standard ISO 4572.

Flow vs. Pressure Loss

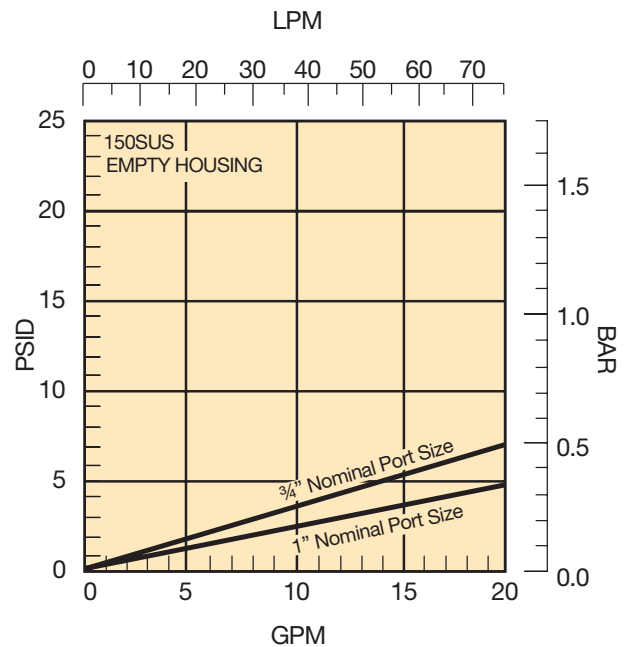
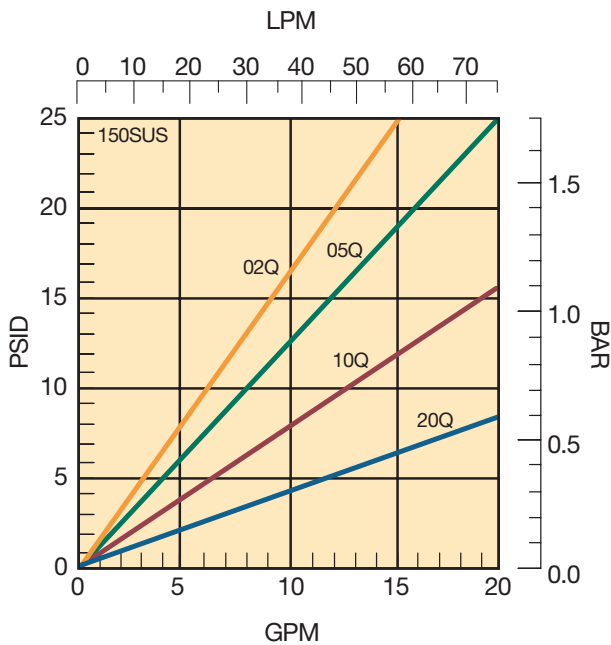

15CN Series

15CN-2 Element Performance

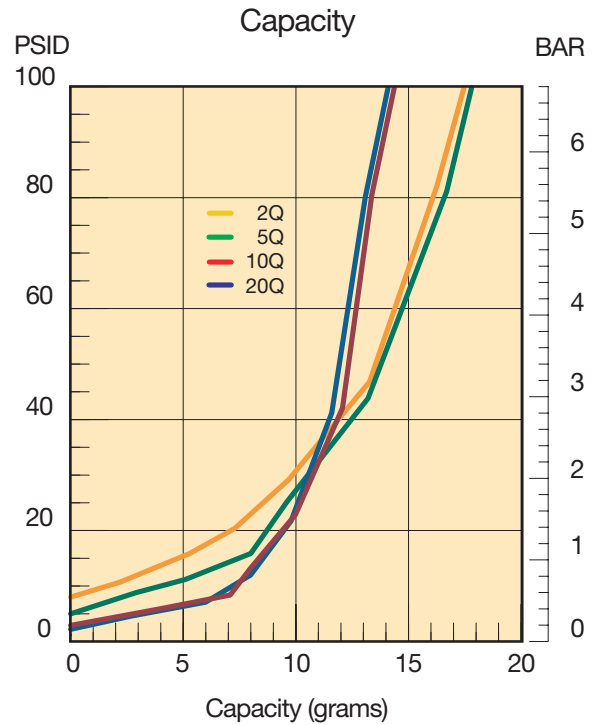
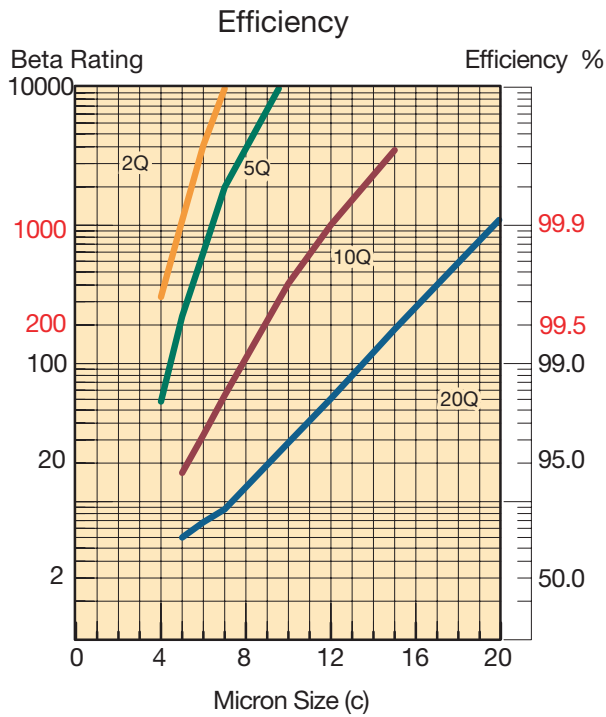

Results typical from Multi-pass tests run per test standard ISO 16889 @ 15 gpm to 100 psid terminal - 10 mg/L BUGL
 Refer to Appendix for relationship to test standard ISO 4572.

Flow vs. Pressure Loss

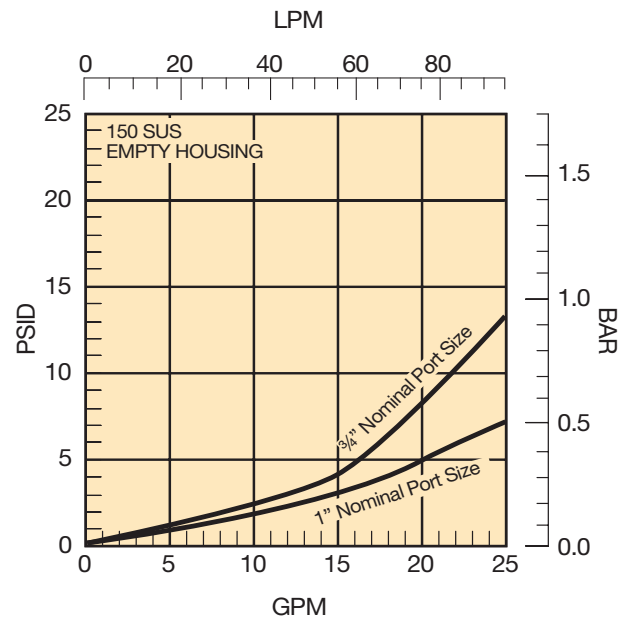
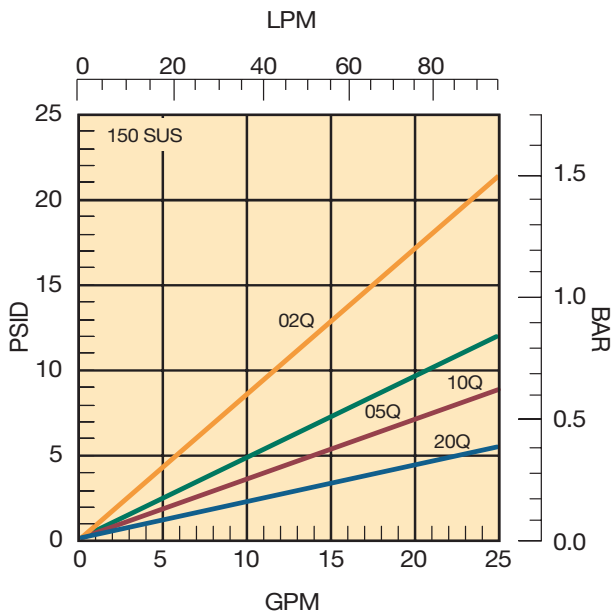

40CN Series

40CN-1 Element Performance

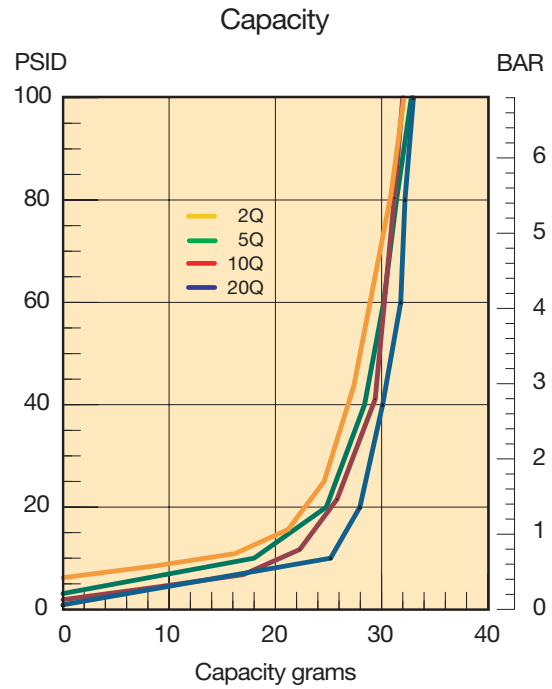
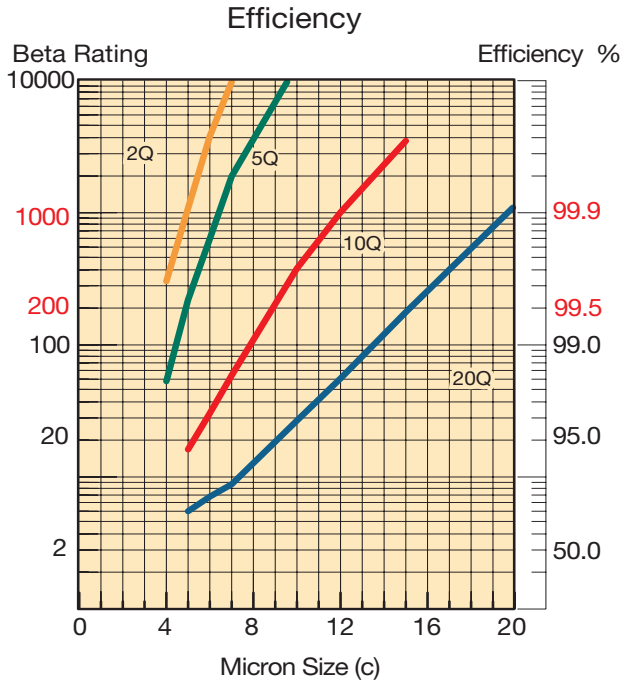

Results typical from Multi-pass tests run per test standard ISO 16889 @ 15 gpm to 100 psid terminal - 10 mg/L BUGL
 Refer to Appendix for relationship to test standard ISO 4572.

Flow vs. Pressure Loss

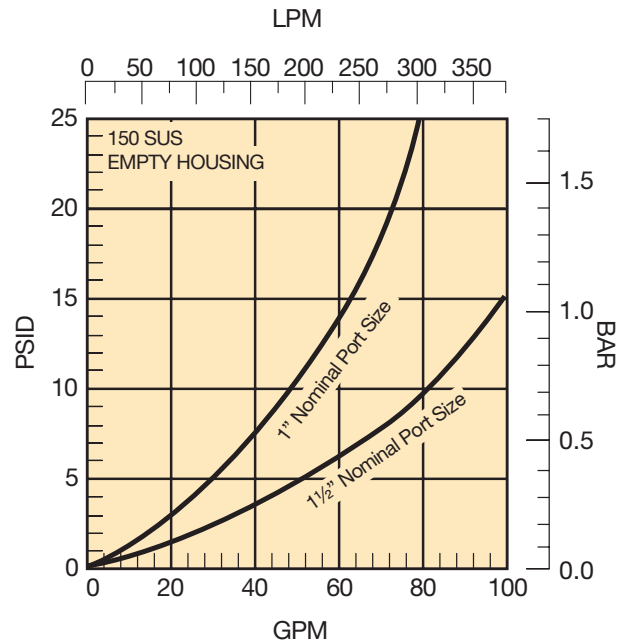
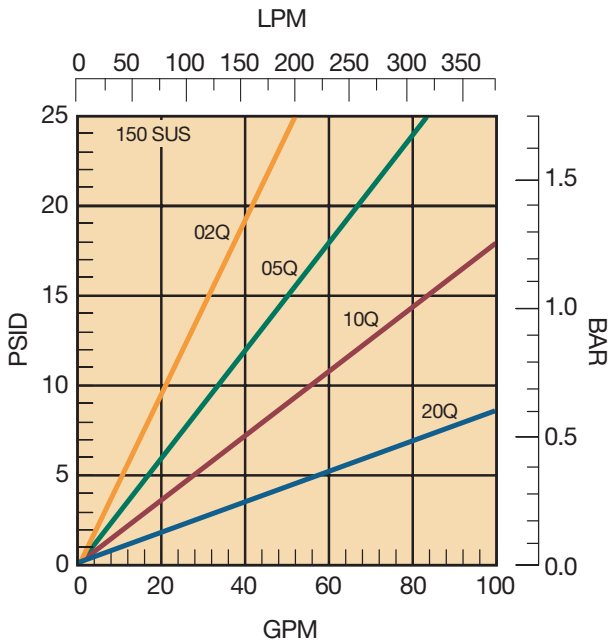

40CN Series

40CN-2 Element Performance

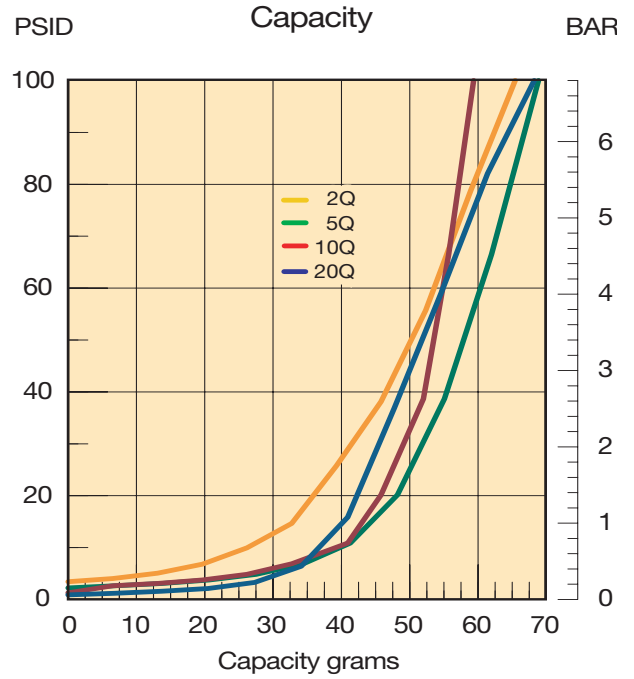
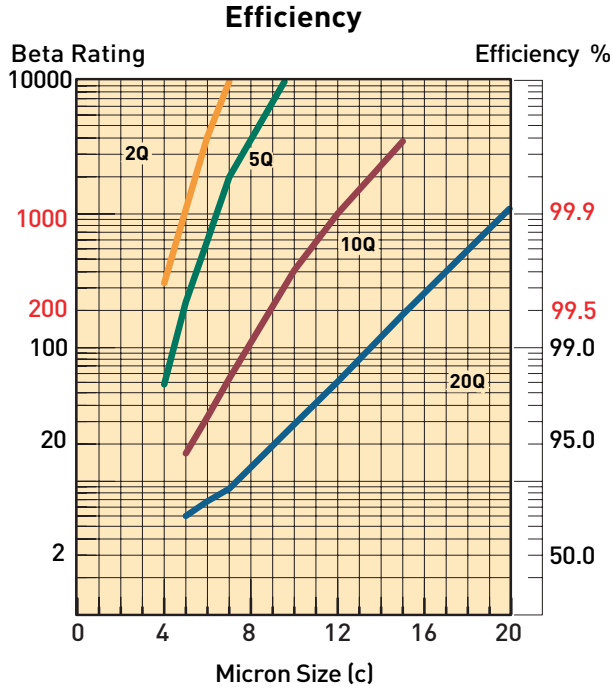

Results typical from Multi-pass tests run per test standard ISO 16889 @ 30 gpm to 100 psid terminal - 10 mg/L BUGL
 Refer to Appendix for relationship to test standard ISO 4572.

Flow vs. Pressure Loss

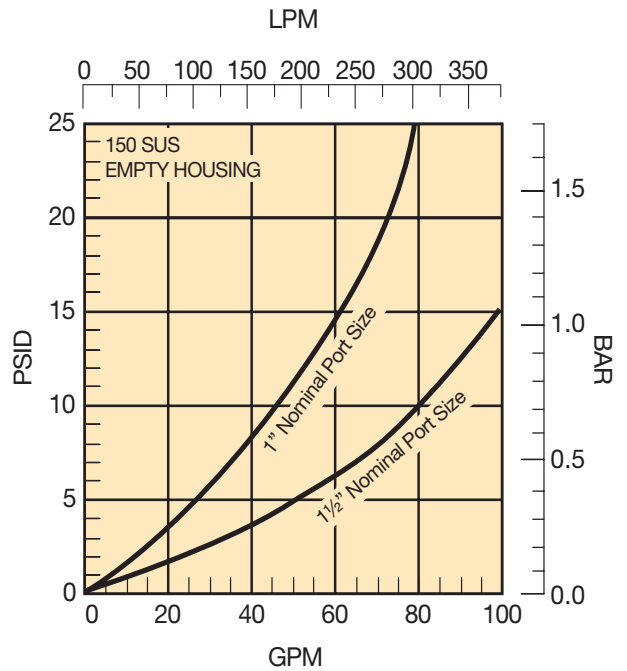
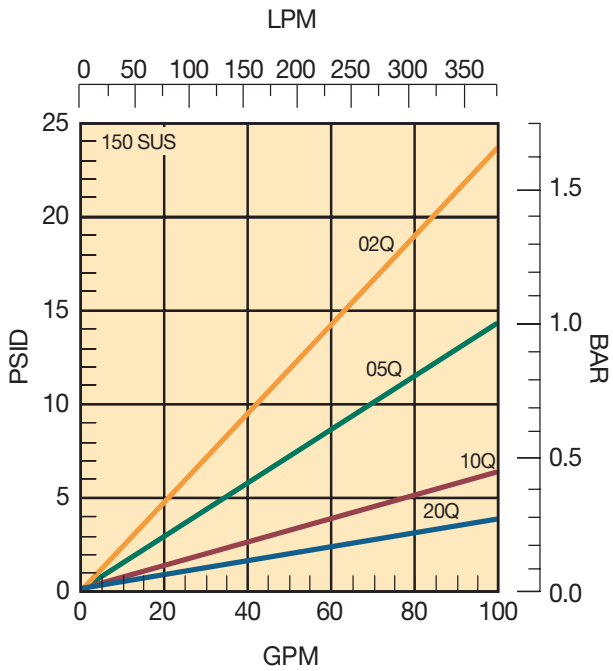

40CN Series

40CN-3 Element Performance

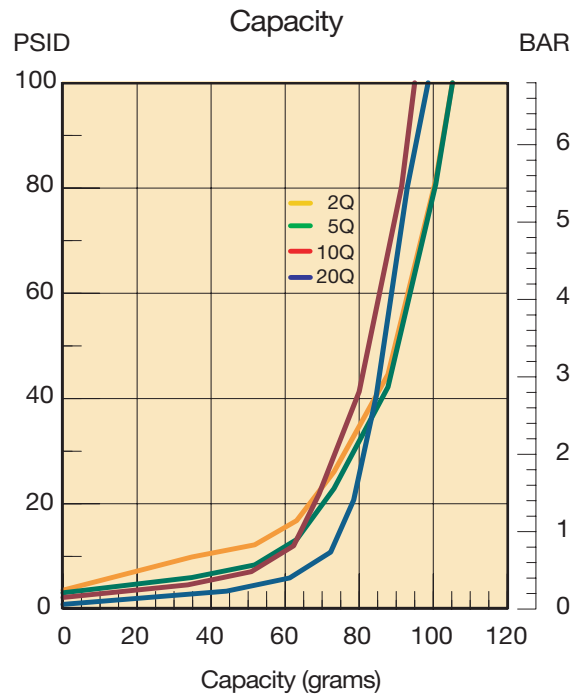
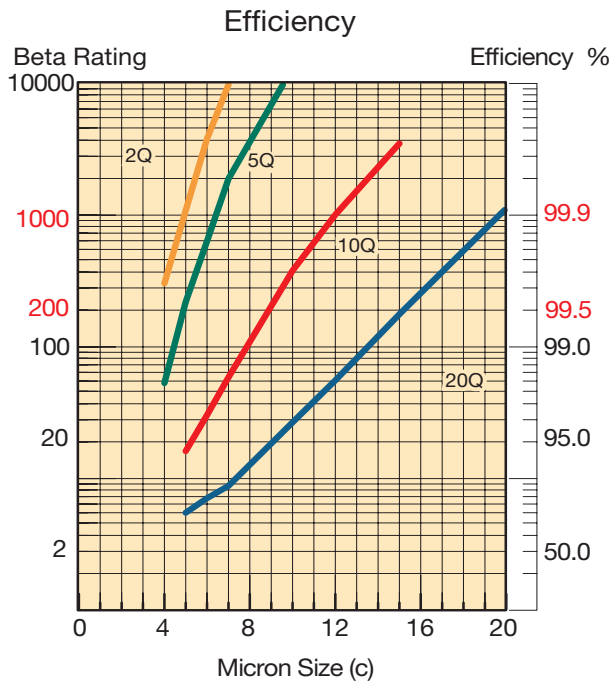

Results typical from Multi-pass tests run per test standard ISO 16889 @ 45 gpm to 100 psid terminal - 10 mg/L BUGL
Refer to Appendix for relationship to test standard ISO 4572.

Flow vs. Pressure Loss

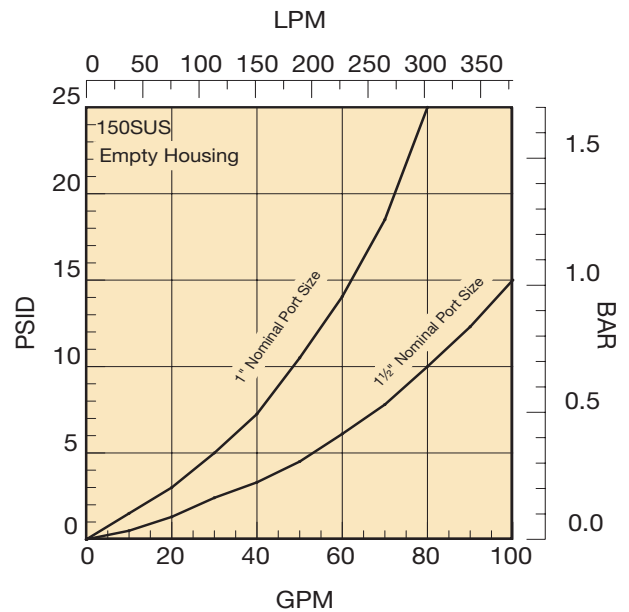
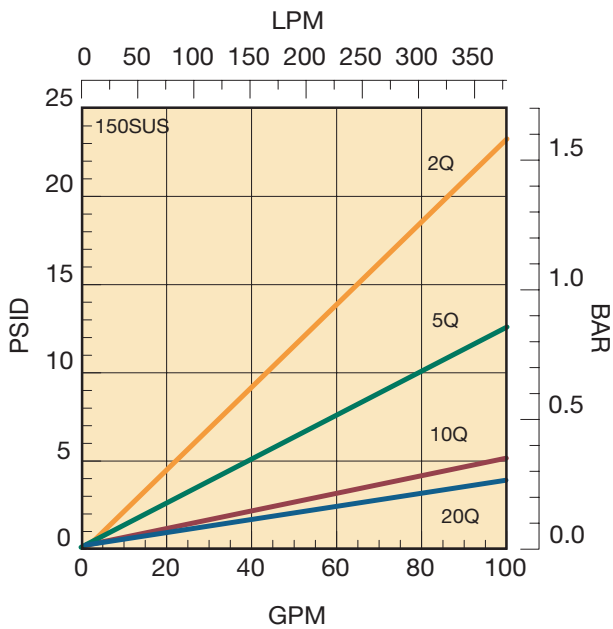

80CN Series

80CN-1 Element Performance

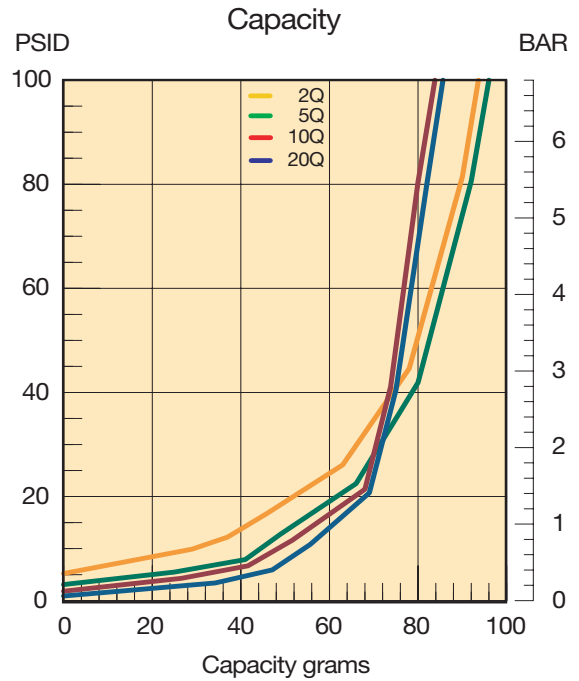
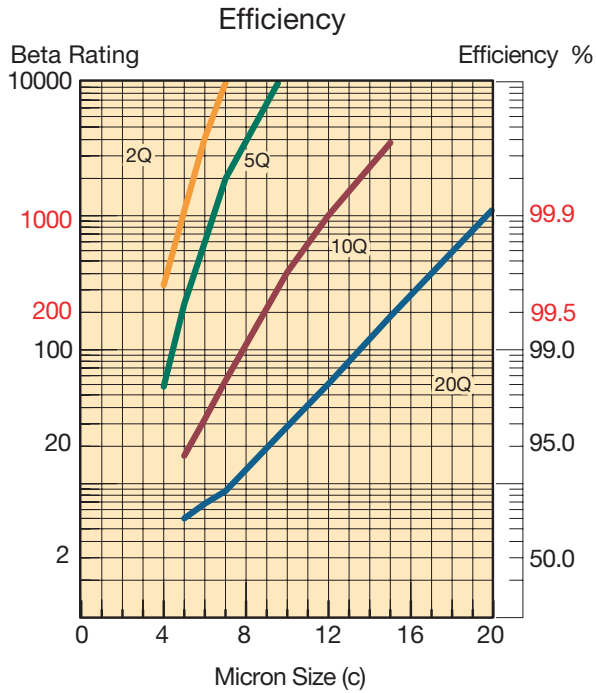

Results typical from Multi-pass tests run per test standard ISO 16889 @ 45 gpm to 100 psid terminal - 10 mg/L BUGL
 Refer to Appendix for relationship to test standard ISO 4572.

Flow vs. Pressure Loss

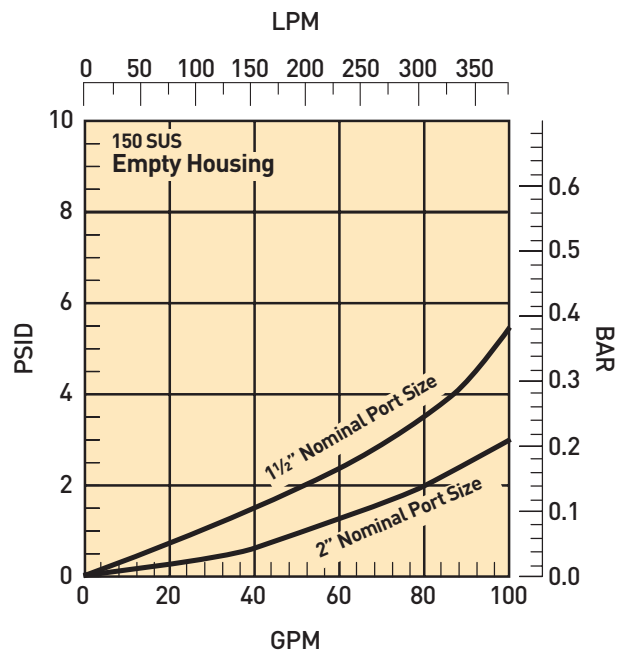
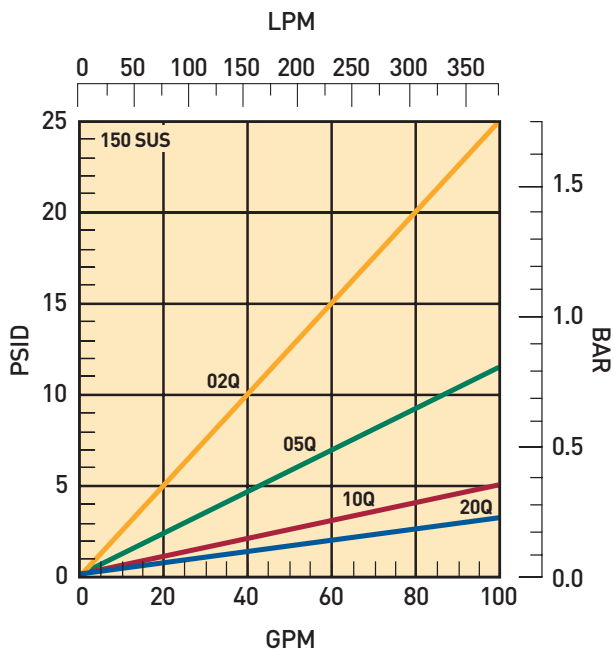

80CN Series

80CN-2 Element Performance

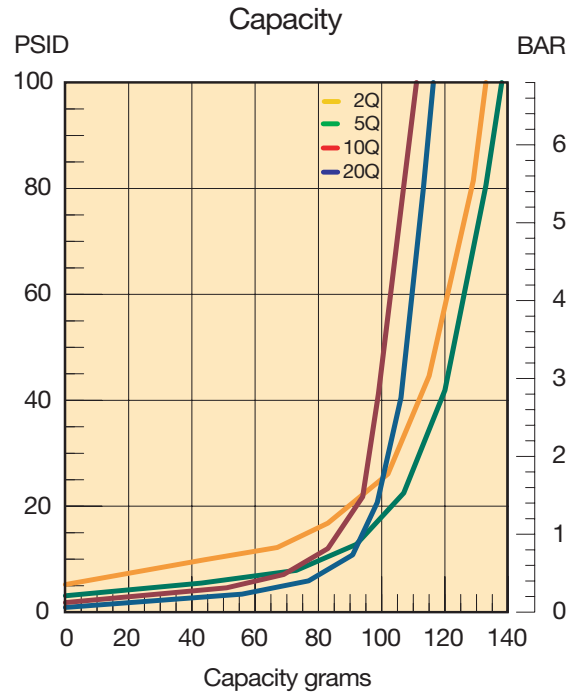
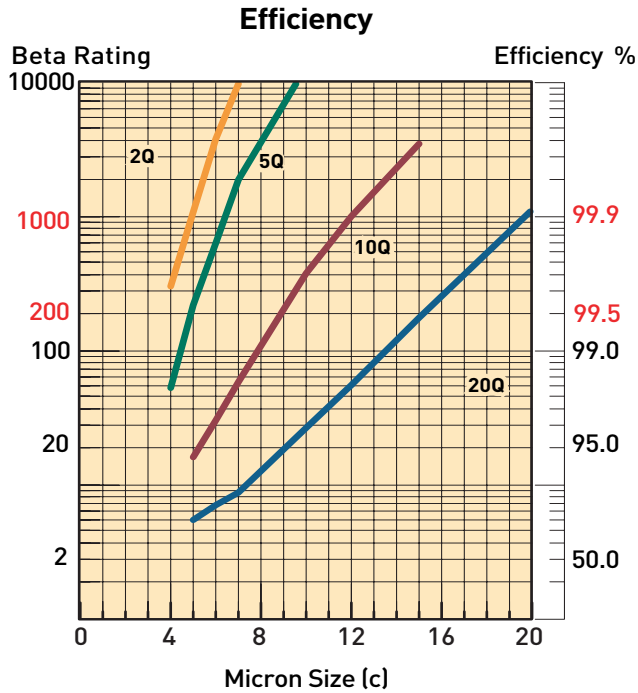

Results typical from Multi-pass tests run per test standard ISO 16889 @ 70 gpm to 100 psid terminal - 10 mg/L BUGL
 Refer to Appendix for relationship to test standard ISO 4572.

Flow vs. Pressure Loss

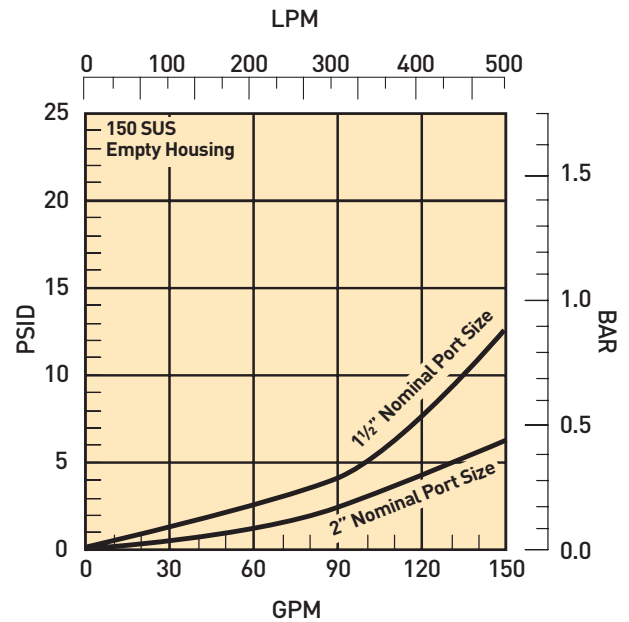
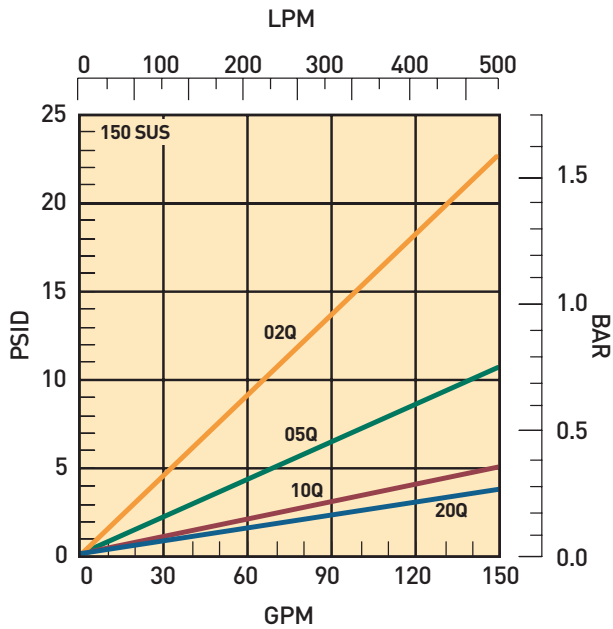

15/40/80CN Series

Specifications

Maximum Allowable Operating Pressure (MAOP):

1000 psi (69 bar)

Rated Fatigue Pressure:

800 psi (55.2 bar)

Design Safety Factor: 2.5:1

Operating Temperatures:

Nitrile: -40°F (-40°C) to 225°F (107°C)

Fluorocarbon: -15°F (-26°C) to 225°F (107°C)

Element Collapse Rating:

Standard: 150 psi (10.3 bar)

Drawings are for reference only.
Contact factory for current version.

Materials:

Head and Bowl: Aluminum
Indicators: Aluminum body, plastic connectors
Bypass: Nylon

Weights (approximate):

Model	Single length	Double length
15CN	2.5 lb. (1.13 kg)	3.5 lb. (1.6 kg)
40CN	4.5 lb. (2.00 kg)	5.5 lb. (2.49 kg)
80CN	12.4 lb. (5.62 kg)	15.2 lb. (6.89 kg)

Element Condition Indicators:

Visual 360° green/red auto reset
Electrical/Visual (E)

5A @ 240VAC, 3A @ 28VDC

Black (common)

Red (normally open)

White (normally closed)

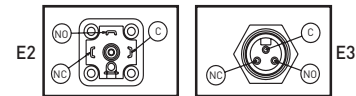

Electrical-Heavy Duty (H)

.25A (resistive) MAX 5 watts

12 to 28 VDC & 110 to 175 VAC

White (common)

Black (normally open)

Blue (normally closed)

Dimensions are in (mm)	A	B	C	D	E	F	G	H	I	J	K	L	M
15CN	6.17 (156.6)	9.87 (250.7)	1.85 (47.0)	1.00 (25.4)	2.80 (71.1)	3.38 (85.9)	2.88 (73.2)	3.25 (82.6)	1.50 (38.1)	.90 (22.9)	1.69 (42.9)	1.44 (36.6)	NA
40CN	6.73 (170.8)	10.33 (262.4)	2.44 (62.0)	1.28 (32.6)	4.22 (107.2)	5.00 (127.0)	4.37 (111.0)	4.80 (121.9)	2.44 (62.0)	1.25 (31.8)	2.32 (58.8)	2.37 (60.2)	15.07 (382.8)
80CN	11.06 (280.9)	15.81 (401.6)	3.06 (77.7)	1.95 (49.5)	4.91 (124.8)	6.25 (158.7)	3.25 (82.6)	5.96 (151.4)	4.00 (101.6)	1.62 (41.1)	3.12 (79.4)	1.63 (41.3)	NA

15CN

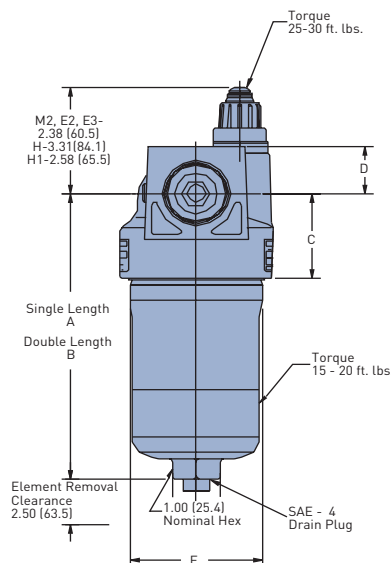
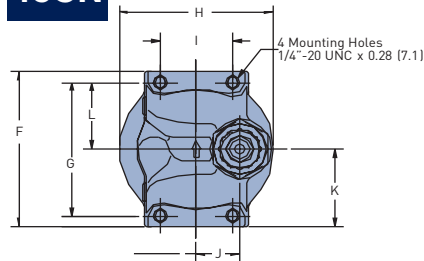

40CN

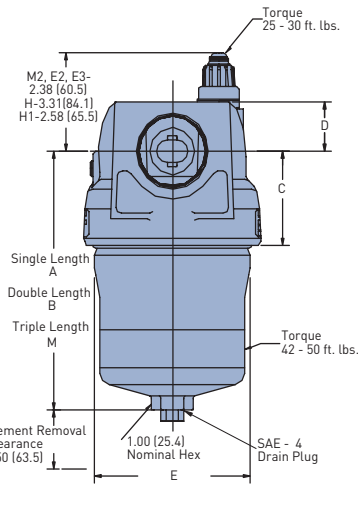
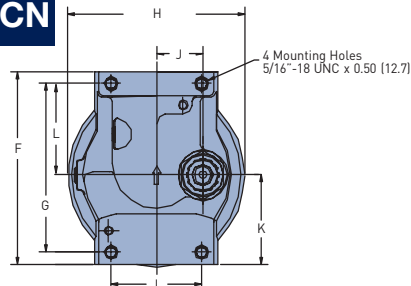

80CN

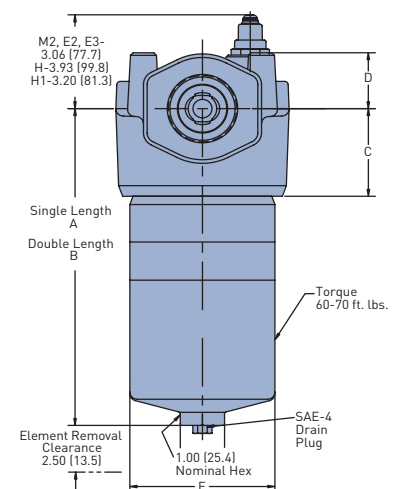
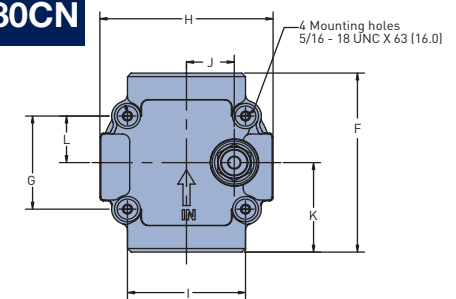

15/40/80CN Series

Element Service Instructions

- A. Stop the system's power unit.
- B. Relieve any system pressure in the filter line.
- C. Drain the filter bowl if drain port option is provided.
- D. Loosen and remove bowl.
- E. Remove element by pulling downward with a slight twisting motion and discard.
- F. Check bowl o-ring for damage and replace if necessary.
- G. Lubricate element o-ring with system fluid and place on post in filter head.
- H. Install bowl and tighten to specified torque.
 - 15CN - 15-20 ft. lbs
 - 40CN - 42-50 ft. lbs
 - 80CN - 60-70 ft. lbs
- I. Confirm there are no leaks after powering the system.

Parts List

Index	Description	15CN	40CN	80CN
1	Head			
	3/4" NPT bypass/ indicator ready	933865	N/A	N/A
	3/4" NPT no bypass/ no indicator	933877	N/A	N/A
	3/4" NPT no bypass/ indicator ready	933869	N/A	N/A
	3/4" NPT no indicator/ bypass ready	933873	N/A	N/A
	SAE-12 bypass/ indicator ready	933863	N/A	N/A
	SAE-12 no bypass/ no indicator	933875	N/A	N/A
	SAE-12 no bypass/ indicator ready	933867	N/A	N/A
	SAE-12 no indicator/ bypass ready	933871	N/A	N/A
	1" NPT bypass/ indicator ready	933864	932950	N/A
	1" NPT no bypass/ no indicator	933876	932986	N/A
	1" NPT no bypass/ indicator ready	933868	932962	N/A
	1" NPT no indicator/ bypass ready	933872	932974	N/A
	SAE-16 bypass/ indicator ready	933862	932947	N/A
	SAE-16 no bypass/ no indicator	933874	932983	N/A
	SAE-16 no bypass/ indicator ready	933866	932959	N/A
	SAE-16 no indicator/ bypass ready	933870	932971	N/A
	1 1/2" NPT bypass/ indicator ready	N/A	932948	934012
	1 1/2" NPT no bypass/ no indicator	N/A	932984	934018
	1 1/2" NPT no bypass/ indicator ready	N/A	932960	934016
	1 1/2" NPT no indicator/ bypass ready	N/A	932972	934014
	SAE-24 bypass/ indicator ready	N/A	932945	934027
	SAE-24 no bypass/ no indicator	N/A	932981	934033
	SAE-24 no bypass/ indicator ready	N/A	932957	934031
	SAE-24 no indicator/ bypass ready	N/A	932969	934029
	2" NPT bypass/ indicator ready	N/A	N/A	934020
	2" NPT no bypass/ no indicator	N/A	N/A	934026
	2" NPT no bypass/ indicator ready	N/A	N/A	934024
	2" NPT no indicator/ bypass ready	N/A	N/A	934022
	SAE-32 bypass/ indicator ready	N/A	N/A	934035
	SAE-32 no bypass/ no indicator	N/A	N/A	934042
	SAE-32 no bypass/ indicator ready	N/A	N/A	934040
	SAE-32 no indicator/ bypass ready	N/A	N/A	934037
	Flange face, SAE 2" bypass/indicator ready	N/A	N/A	934103
	Flange face, SAE 2" no bypass/no indicator	N/A	N/A	934109
	Flange face, SAE 2" no bypass/indicator ready	N/A	N/A	934107
	Flange face, SAE 2" no indicator/bypass ready	N/A	N/A	934105
	Indicators			
2	M2-Visual auto reset/ 25 psi	932026	932026	932026
	M2-Visual auto reset/ 50 psi	932027	932027	932027
3	H-Electrical/ 25 psi w/ 1/2" conduit connection	933053	933053	933053
	H-Electrical/ 50 psi w/ 1/2" conduit connection	932905	932905	932905
	H1-Electrical/ 25 psi w/ wire leads	933054	933054	933054
	H1-Electrical/ 50 psi w/ wire leads	932906	932906	932906
	Not Shown:			
	E-Electrical/Visual 25 psi w/ wire leads	929610	929610	929610
	E-Electrical/Visual 50 psi w/ wire leads	929587	929587	929587
4	E2-Electrical/Visual 25 psi w/ DIN connection	931153	931153	931153
	E2-Electrical/Visual 50 psi w/ DIN connection	929599	929599	929599
5	E3-Electrical/Visual 25 psi w/ 3-pin connection	932773	932773	932773
	E3-Electrical/Visual 50 psi w/ 3-pin connection	929596	929596	929596
6	Bypass Valve			
	25 psid assembly	928979	930507	933628
	50 psid assembly	928981	933424	933630
	Not Shown:			
	No bypass plug	935744	927719	934174
7	Element (see model code page)			
8	Bowl			
	Single length	936758	936760	936763
	Double length	936759	936761	936764
	Triple length	-	936762	-
9	Bowl and Dust Seal			
	Buna N (Nitrile)	N72142	N72239	N72244
	Fluorocarbon	V72142	V72239	V72244
10	Drain Plug - SAE-4			
	Buna N (Nitrile)	921088	921088	921088
	Fluorocarbon	928882	928882	928882

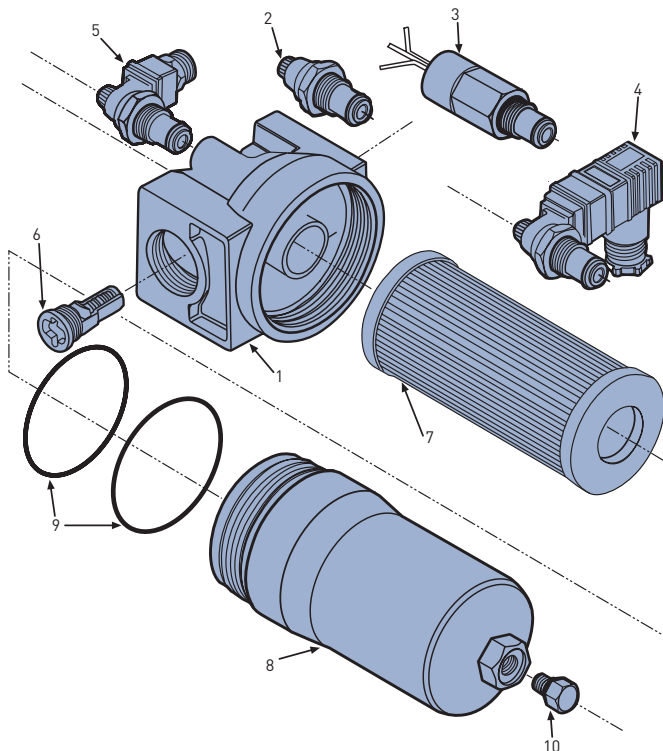

15/40/80CN Series¹

Coreless Medium Pressure Filters

How To Order

Select the desired symbol (in the correct position) to construct a model code. Example:

BOX 1	BOX 2	BOX 3	BOX 4	BOX 5	BOX 6	BOX 7	BOX 8
40CN	2	10QE	B	M2	K	S16	4

BOX 1: Filter Series	
Symbol	Description
15CN	3/4" nominal ports
40CN	1-1/2" nominal ports
80CN	2" nominal ports

BOX 4: Seals	
Symbol	Description
B	Nitrile
E	Ethylene Propylene
V	Fluorocarbon

BOX 7: Ports	
Symbol	Description
15CN	
N12	3/4" NPT
N16	1" NPT
S12	SAE-12 straight threads
S16	SAE-16 straight threads
40CN	
N16	1" NPT
N24	1-1/2" NPT
S16	SAE-16 straight threads
S24	SAE-24 straight threads
80CN	
N24	1-1/2" NPT
N32	2" NPT
S24	SAE-24 straight threads
S32	SAE-32 straight threads
Y32	2" SAE Flange face, Code 61

BOX 2: Element Length	
Symbol	Description
1	Single
2	Double
3	Triple (40CN only)

BOX 5: Indicator	
Symbol	Description
P	Port plugged
M2	Visual Automatic Reset
E2	Electrical/Visual (DIN43650 Hirschman style connection)

BOX 3: Media	
Symbol	Description
02QE	Microglass, 2 micron
05QE	Microglass, 5 micron
10QE	Microglass, 10 micron
20QE	Microglass, 20 micron

BOX 6: Bypass	
Symbol	Description
G	25 psi (1.7 bar)
K	50 psi (3.5 bar)

BOX 8: Options	
Symbol	Description
4	Drain port
21 ²	No bypass with drain port

- Filters include the element you select already installed.
- When an indicator is chosen in conjunction with the no bypass ("21") option, Box 6 denotes the indicator calibration.

Replacement Elements

Media	15CN-1	15CN-2	40CN-1	40CN-2	40CN-3	80CN-1	80CN-2
02QE	936698Q	936702Q	936706Q	936710Q	936622Q	936713Q	936716Q
05QE	936699Q	936703Q	936707Q	936711Q	936623Q	936714Q	936717Q
10QE	936700Q	936704Q	936708Q	936601Q	936720Q	936602Q	936718Q
20QE	936701Q	936705Q	936709Q	936712Q	936721Q	936715Q	936719Q

